

# Gas Stick Assemblies

## VUP Series

### Product Features

- Ultra high purity gas stick for all gas delivery systems
  - 100TG: ≤30 slpm delivery 1/4" VFS
  - 200TG: ≤300 slpm delivery 3/8" VFS
  - 300TG: ≤600 slpm delivery 1/2" VFS
- High control accuracy
- All connections welded or VFS
- Manual or pneumatic diaphragm valve option
- 100% Helium-leak-tested

### Technical Data

Inlet pressure P1:	300 psig
Outlet pressure P2:	30/60/100/150 psig
Diaphragm valve materials	
body:	316L
Valve seat:	PCTFE
Diaphragm:	Elgiloy®
Regulator materials	
body:	316L / 316L secondary remelt
Valve seat:	PCTFE
Diaphragm:	Hastelloy® C276
Leak rate: (to atmosphere)	1x10 <sup>-9</sup> mbar l/s He
(via seat)	1x10 <sup>-8</sup> mbar l/s He



### Dimensions (mm)

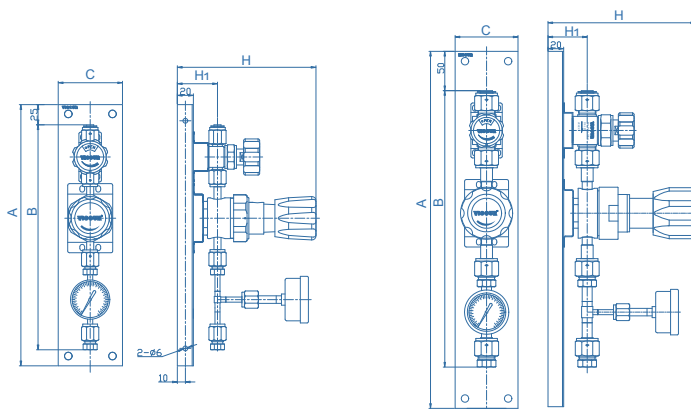

VUP-100TG (A Type)

VUP-200TG / VUP-300TG (A Type)

Type	Panel Thickness mm	Ordering Number	Dimensions, mm				
			A	B	C	H	H1
100TG	20	VUP-100TG-A	325	280	80	172.5	50
200TG	20	VUP-200TG-A	455	352.4	80	188	50
300TG	20	VUP-300TG-A	455	349.2	80	188	50

# Gas Stick Assemblies VUP Series

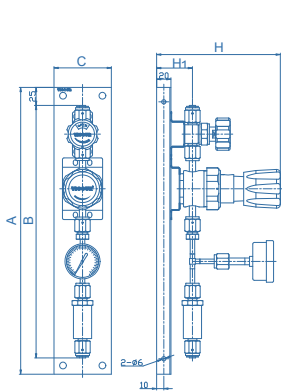

VUP-100TG (B Type)

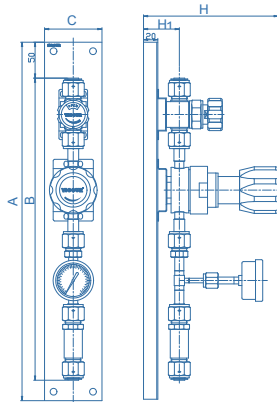

VUP-200TG / VUP-300TG (B Type)

Type	Panel Thickness mm	Ordering Number	Dimensions, mm				
			A	B	C	H	H1
100TG	20	VUP-100TG-B	400	352.3	80	172.5	50
200TG	20	VUP-200TG-B	500	421.4	80	188	50
300TG	20	VUP-300TG-B	500	418.2	80	188	50

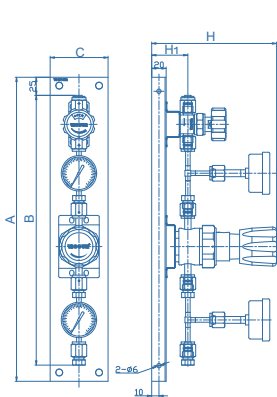

VUP-100TG (C Type)

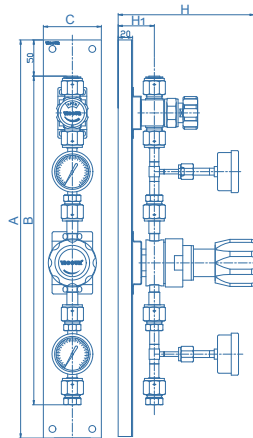

VUP-200TG / VUP-300TG (C Type)

Type	Panel Thickness mm	Ordering Number	Dimensions, mm				
			A	B	C	H	H1
100TG	20	VUP-100TG-C	420	372.6	80	172.5	50
200TG	20	VUP-200TG-C	550	454.1	80	188	50
300TG	20	VUP-300TG-C	550	447.7	80	188	50

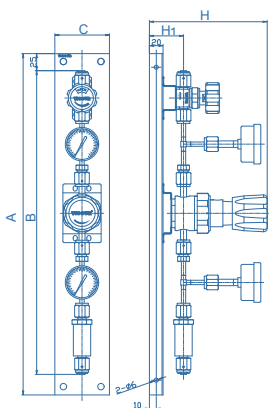

VUP-100TG (D Type)

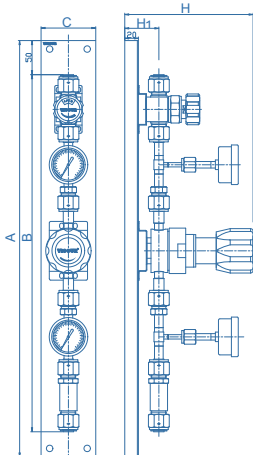

VUP-200TG / VUP-300TG (D Type)

Type	Panel Thickness mm	Ordering Number	Dimensions, mm				
			A	B	C	H	H1
100TG	20	VUP-100TG-D	500	444.9	80	172.5	50
200TG	20	VUP-200TG-D	610	523.1	80	188	50
300TG	20	VUP-300TG-D	610	516.7	80	188	50

# Gas Stick Assemblies

## VUP Series

### Ordering Information

VUP - 100TG - D - 20 - 10 - FV4 - P - P - FV4 - F - PC

